

PLAN

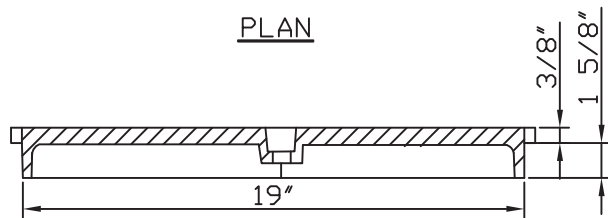

SEC 'A-A'

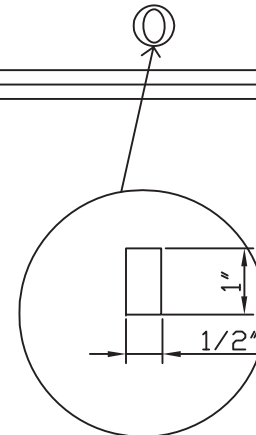
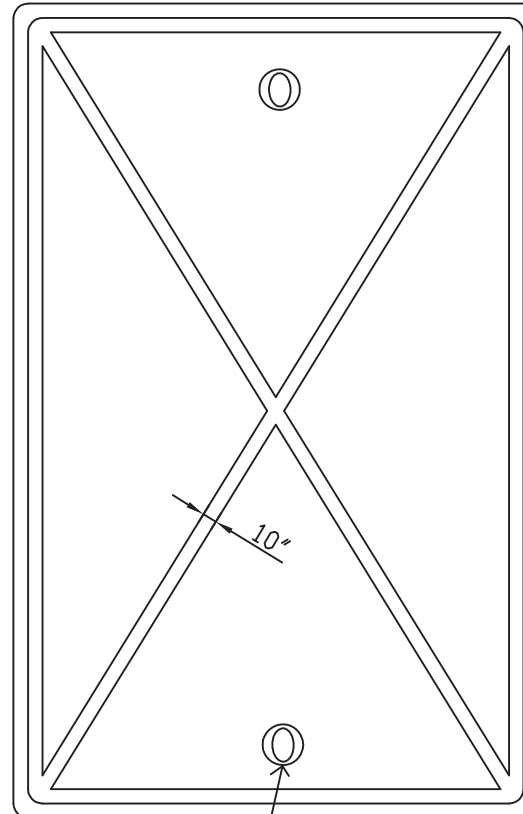
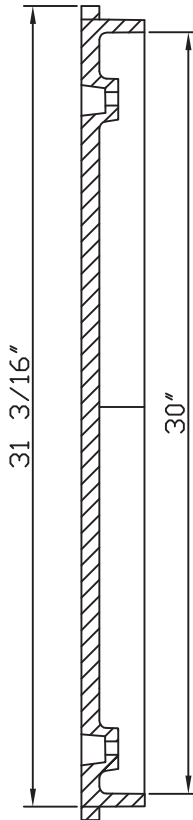

7520 Conrad Street  
Burnaby, BC V5A 2H7

Phone : 604 415 5181  
Fax : 604 415 5185

DRAWN BY: P.S DATE: 04/2007

APPROVED:

REVISION:

SCALE: NOT TO SCALE

LOAD RATING

H-20

MATERIAL SPECIFICATION

ASTM A 48

COATING

BITUMINOUS TAR COATED  
(UNCOATED ON REQUEST)

ESTIMATED WEIGHT -

86 LBS.

PART / DWG NUMBER

D266-Blank

CATALOG NUMBER

D266:-Cast Iron Cover Meter Box "Blank"

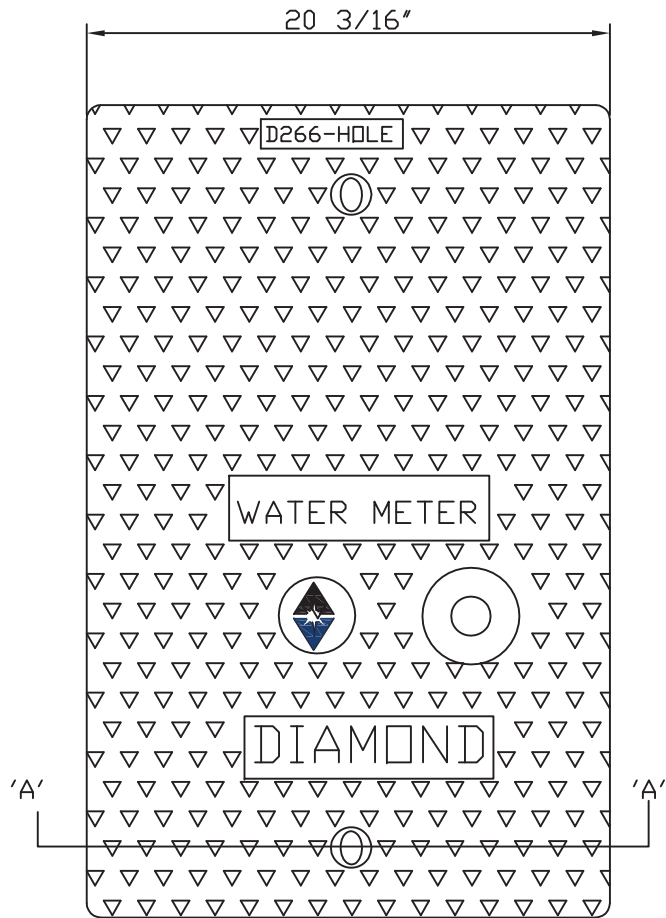

PLAN

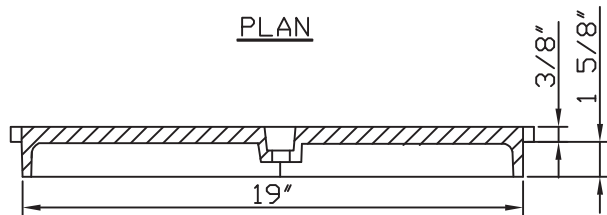

SEC 'A-A'

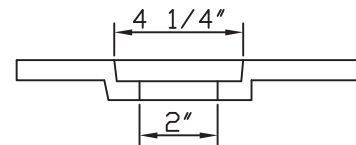
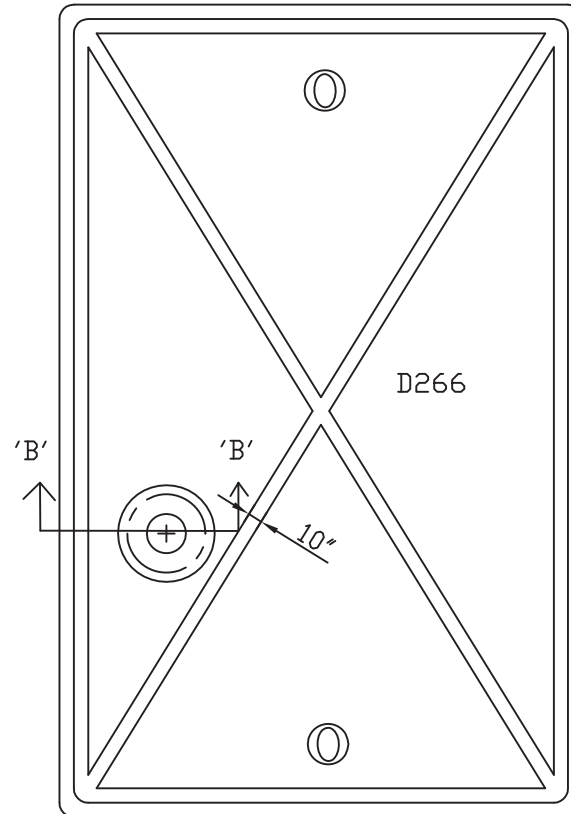
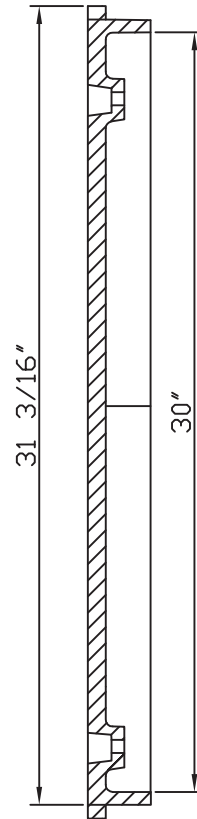

SEC 'B-B'



7520 Conrad Street  
Burnaby, BC V5A 2H7

Phone : 604 415 5181  
Fax : 604 415 5185

DRAWN BY: P.S DATE: 04/2007

APPROVED:

REVISION:

SCALE: NOT TO SCALE

LOAD RATING

H-20

MATERIAL SPECIFICATION

ASTM A 48

COATING

BITUMINOUS TAR COATED  
(UNCOATED ON REQUEST)

ESTIMATED WEIGHT -

86 LBS.

PART / DWG NUMBER

D266 -Hole

CATALOG NUMBER

D 266:- Cast Iron Cover Meter Box marked "Water Meter" with Hole